

P3330-28WDT Greta

Views and ground plan - Julkisivut ja pohjapiirustus - Fasader och grundplan

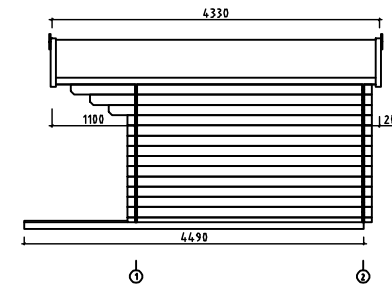

House	P3330-28WDT Greta	Sheet	1
Drawing	Views-kuvat-sedd	Scale	1:100
Material	28x135	Date	03.12.2013
Drawer		File	P3330-28WDT Greta.dwg

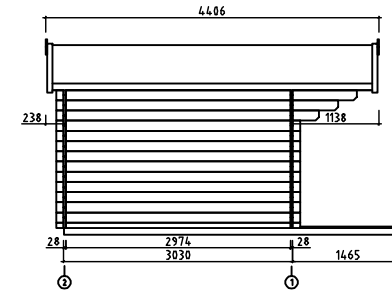
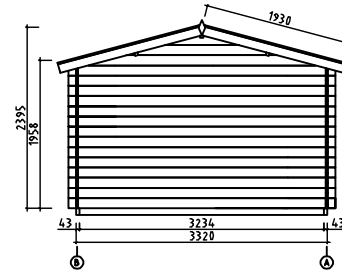
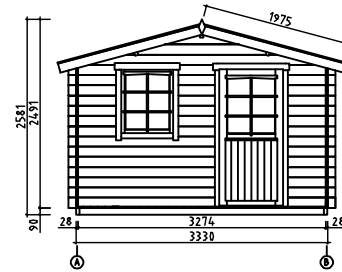
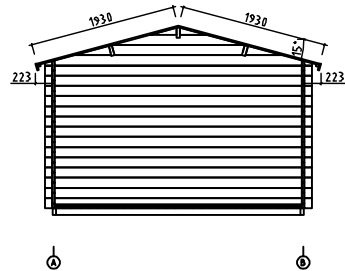
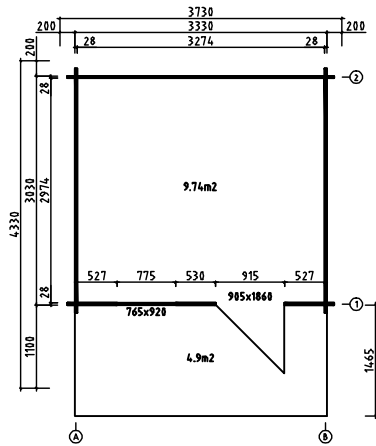
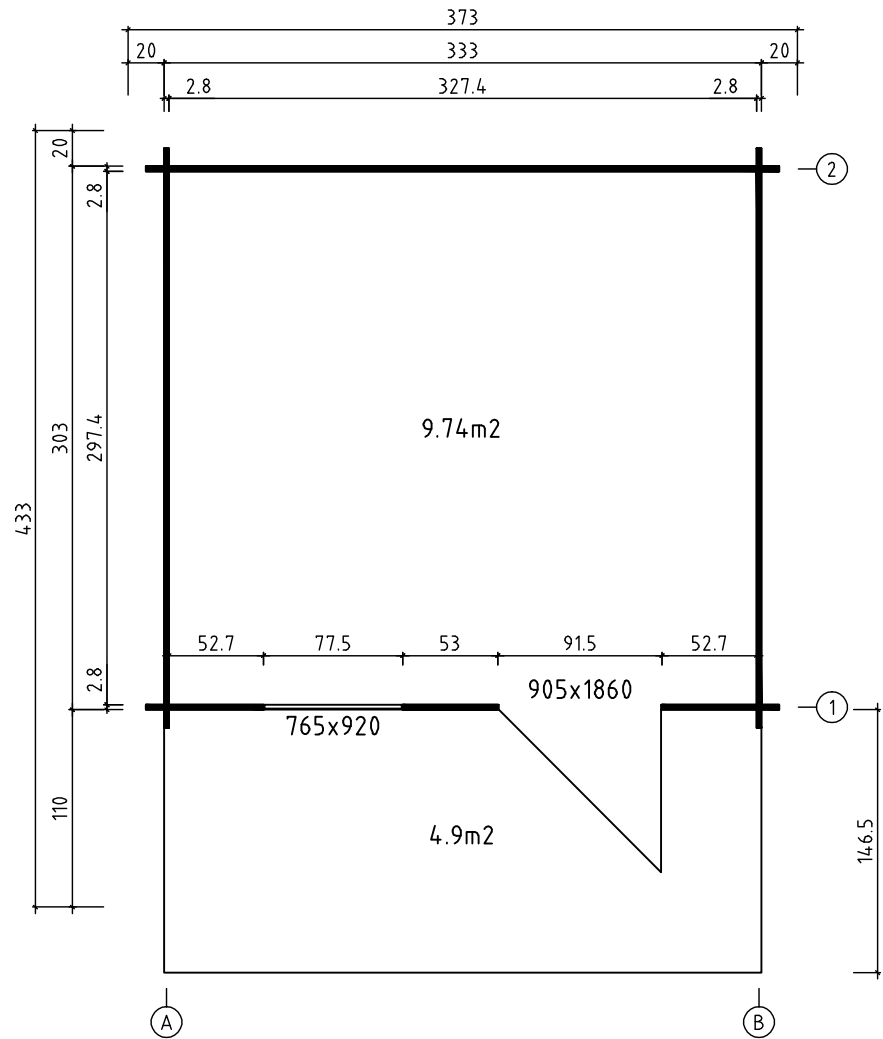

House	P3330-28WDT Greta	Sheet	3	
Drawing	Groundplan-Pohjapiirustus-Grundplan	Scale	1:35	
Material	28x135	Date	02.12.2013	
Drawer			File	P3330-28WDT Greta.dwg

Wall-seinä-vägg A ↗

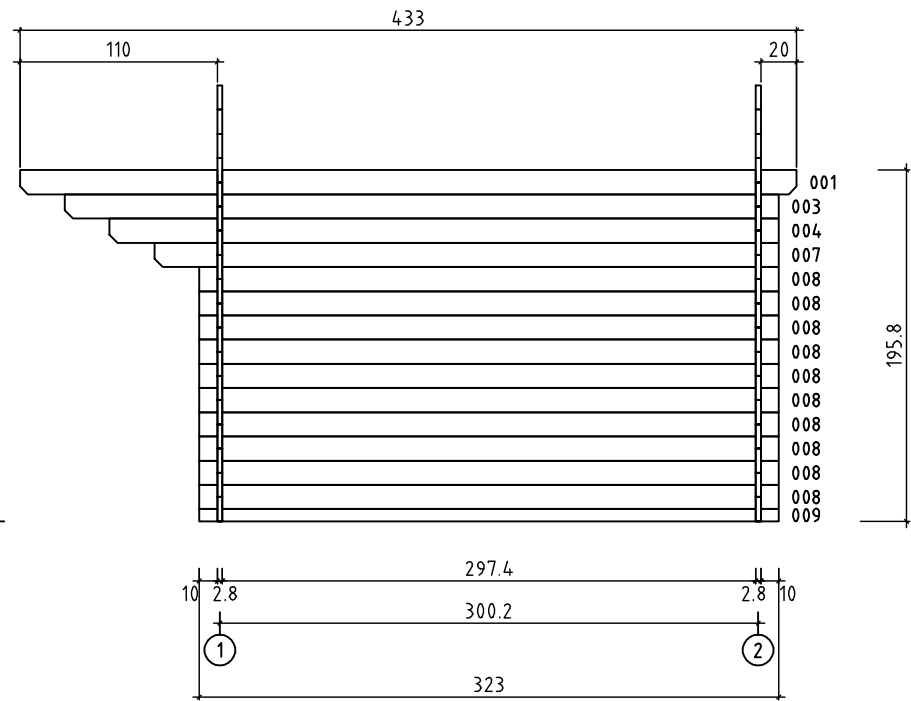

House	P3330-28WDT Greta	Sheet	4
Drawing	Wall-seinä-vägg A	Scale	1:35
Material	2.8x13.5	Date	02.12.2013
Drawer	File P3330-28WDT Greta.dwg		

Wall-seinä-vägg B ↗

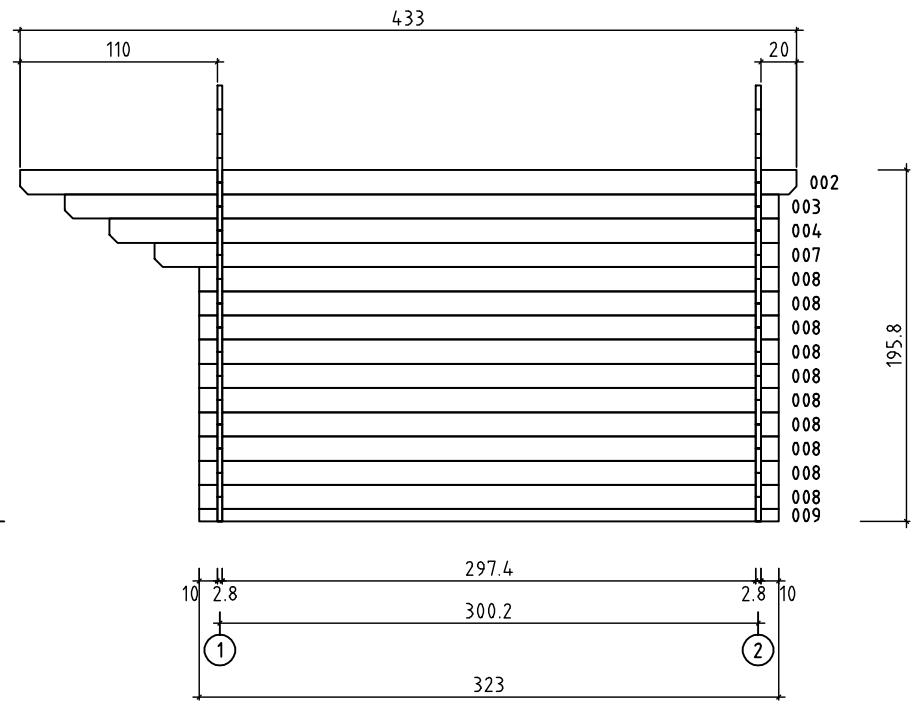



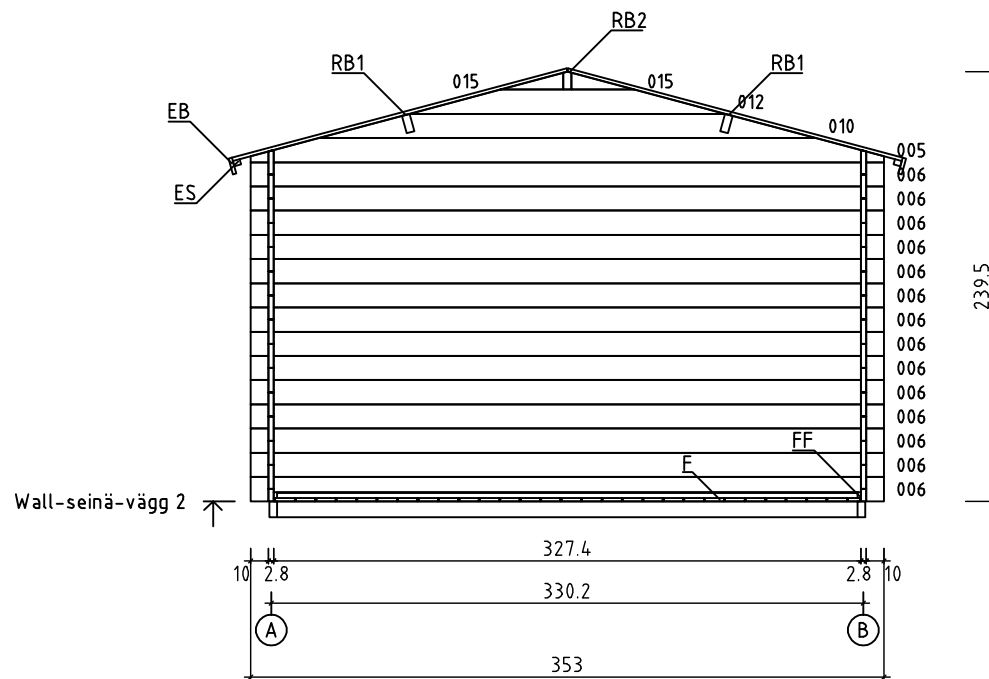







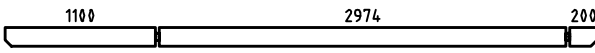
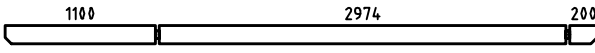
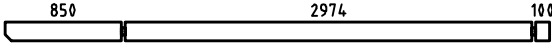
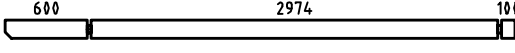
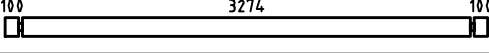
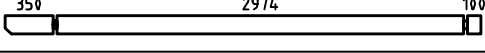
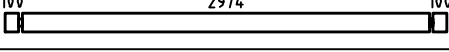
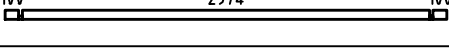
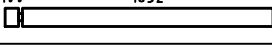

House	P3330-28WDT Greta	Sheet	5	
Drawing	Wall-seinä-vägg B	Scale	1:35	
Material	2.8x13.5	Date	02.12.2013	
Drawer			File	P3330-28WDT Greta.dwg

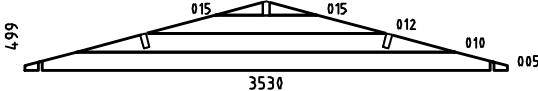

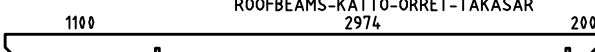
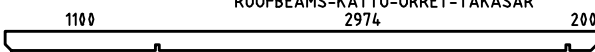
Wall-seinä-vägg 2

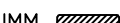

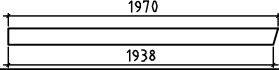
House	P3330-28WDT Greta	Sheet	7
Drawing	Wall-seinä-vägg 2	Scale	1:35
Material	2.8x13.5	Date	02.12.2013
Drawer	File P3330-28WDT Greta.dwg		

Pos	P3330-28WDT Greta	Pcs.	Profile (mm)	L (mm)
001		1	28x135	4330
002		1	28x135	4330
003		2	28x135	3980
004		2	28x135	3730
006		14	28x135	3530
007		2	28x135	3480
008		20	28x135	3230
009		2	28x68	3230
011		7	28x135	1960
013		21	28x135	655
014		7	28x135	530
W1-1		1	28x499	3530
W2-1		1	28x499	3530
FB1	FLOORBEAM-LATTIAPALKIT-GOLVBJÄLKAR 	2	43x90	4490
FB2	FLOORBEAM-LATTIAPALKIT-GOLVBJÄLKAR 	10	43x90	3234
RB1	ROOFBEAMS-KATTO-ORRET-TÄKASAR 	2	43x140	4330
RB2	ROOFBEAMS-KATTO-ORRET-TÄKASAR 	1	43x140	4330
F	FLOORBOARD-LATTIALAUTA-GOLVBRÄDE  or-oder-of	29+1 38+1	114x19 88x19	2970 2970
R	ROOFBOARD-KATTOLAUTA-TAKBRÄDE  or-oder-of	76 100	114x19 88x19	1930 1930
T	TERRACE BOARD-TERASSILAUTA-TERASSBRÄDE  IMM	37	90x19	1460
FF	FLOOR FILLET-LATTIALISTA-GOLVLIST 		18x30	12.5m
GB	GABLE BOARD-KAAPELILAUTA-VINDBRÄDE 	4	19x120	1970
EB	EAVE BOARD-RÄYSTÄSLAUTA-TAKFOTBRÄDE 	2	19x90	4330













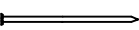

Polhus

Kood P3330-28WDT Greta

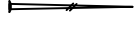
Materjal

File P3330-28WDT Greta.dwg

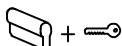
Leht 1/2

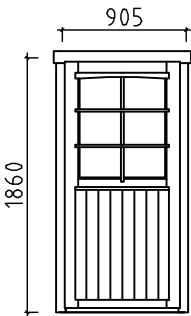
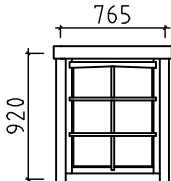
Pos	P3330-28WDT Greta	Pcs.	Profile (mm)	L (mm)
ES	EAVE SLAT-RÄYSTASLISTA-TAKFOTLIST 	2	30x40	4330
RFF	ROOF FELT FILLET - KATON PÄÄTYLAUTA - TAKBRÄDE FÖR VINDBRÄDE 	4	19x70	1980
D	DECORATIVE - KORISTE - PRYDNADS 	2	19x100	200
	BOARD FOR ASSEMBLING - ASENNUSLAUTA - MONTERINGSBRÄDE 	2	28x135	300
	NAILS - NAULAT - SPIKAR  FLOORBOARD - LATTIALAUTA - GOLVBRÄDE ROOFBOARD - KATTOLAUTAT - TAKBRÄDE	535	2,5x60	
	NAILS - NAULAT - SPIKAR  FLOORBEAMS - LATTIAPALKIT - GOLVBJÄLKAR	40	5,0x100	
	SCREWS - RUUVIT - SKRUVAR  ROOF FELT FILLET-KATON PÄÄTYLAUTA-TAKBRÄDE FÖR VINDBRÄDE SKIRTING SLAT - LATTIALISTA - GOLVLIST	45	3,5x35	
	SCREWS - RUUVIT - SKRUVAR  EAVE BOARD - RÄYSTASLAUTA - TAKFOTSBRÄDE EAVE SLAT - RÄYSTASLISTA - TAKFOTSLIST GABLE BOARD - KAAPELILAUTA - VINDBRÄDE TERRACE BOARD - TERRASILAUTA - TERASSBRÄDE	345	4,5x50	
	SCREWS - RUUVIT - SKRUVAR  FIXING HALF BEAMS VAHVISTETTAVA PUOLIKKAAT PALKIT FÖR ATT FASTA HALVA VÄGGPROFILER	10	4,5x90	
	DOOR CROSSES-OVIRISTIKKO-DÖRRLIST 	1		
	DOOR HANDLE-OVEN KAHVA-DÖRR HANDTAG 	1		
	WINDOW CROSSES-IKKUNARISTIKKO-FÖNSTERLIST 	1		
	WINDOW HANDLE-IKKUNA KAHVA-FÖNSTER HANDTAG 	1		
	DOOR LOCK+KEYS-OVENLUKKO+AVAIN-DÖRRLÅS+NYCKLAR  + 	1+1		
	<p>DOOR - OVI - DÖRR 905x1860 1 set - kpl - st (right hand - oikea käsi - höger hand)</p>  <p>WINDOW - IKKUNAN - FÖNSTER - 765x920 1 set - kpl - st (right hand - oikea käsi - höger hand)</p> 	1	905	1860
		1	765	920



Kood P3330-28WDT Greta

Materjal

File P3330-28WDT Greta.dwg

Leht 2/2