

Date rev. Description

House	F294-1-28 Amanda	Sheet	1
Drawing	3D Plan	Scale	
Material	28x135	Date	14.01.2014
Drawer	RP	File	F294-1-28 Amanda 3D.dwg

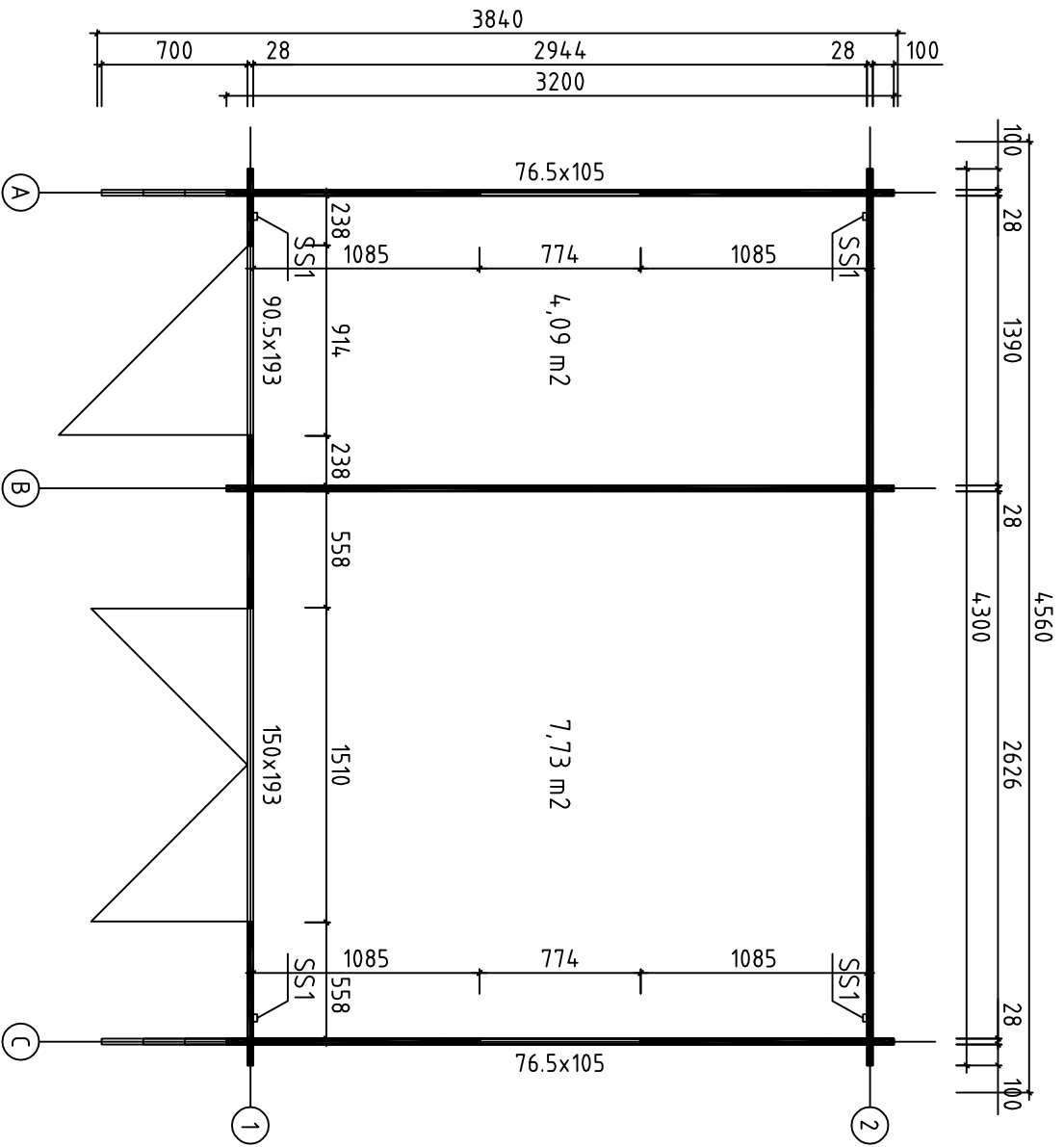

House	F2941-28 Amanda	Sheet	2
Drawing	PLAN-SUUNNITELMA-PLANEN	Scale	1:35
Material	28x135	Date	14.01.2013
Drawer	RP	File	F2941-28 Amanda.dwg

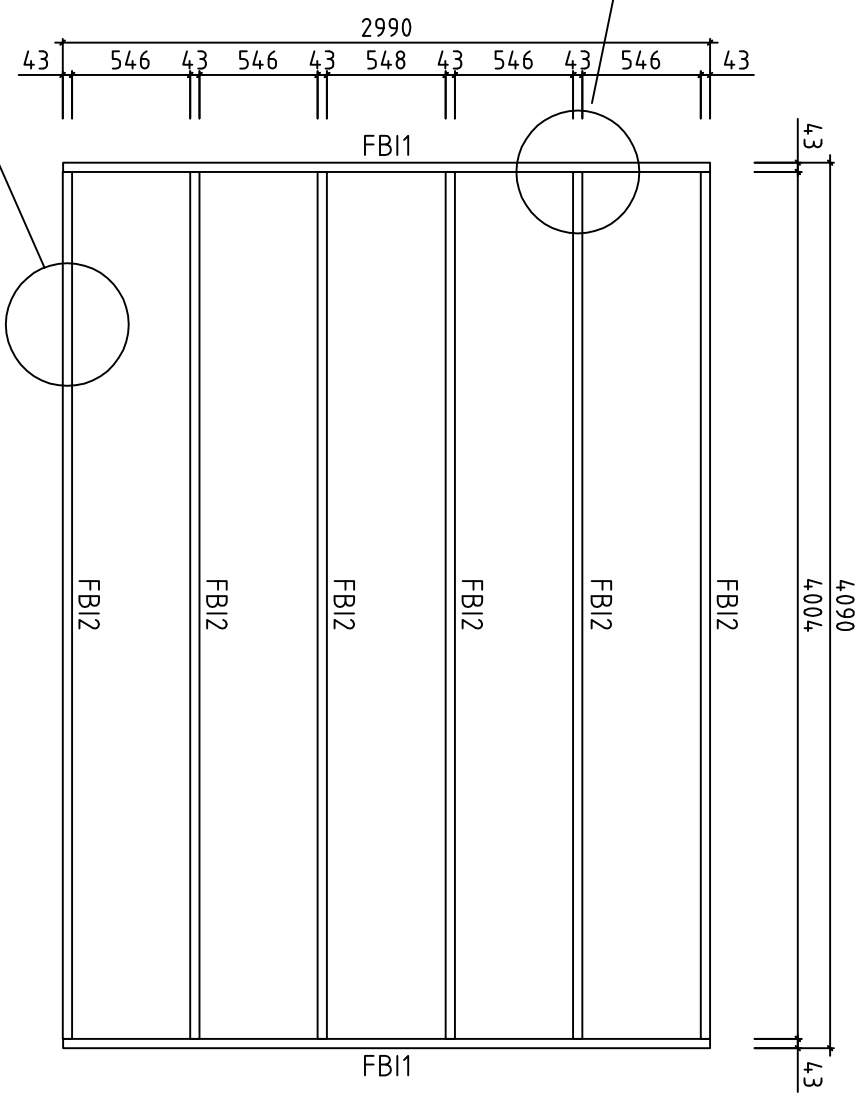

House	F2941-28 Amanda	Sheet	3
Drawing	FLOORBEAMS-LATTIAPALKIT-GOLVBJÄLKAR	Scale	1:35
Material	4.3X70	Date	14.01.2013
Drawer	RP	File	F2941-28 Amanda.dwg

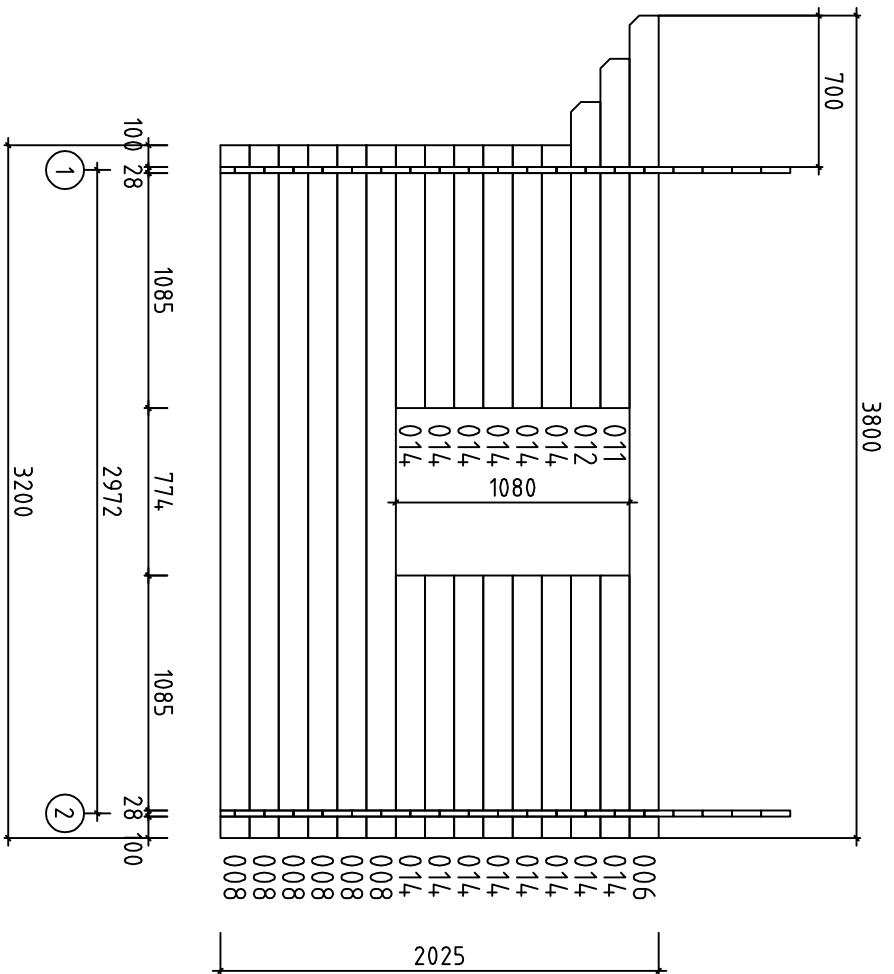

Wäll-Seinä-Vägg A ↗

House	F2941-28 Amanda	Sheet	4
Drawing	WÄLL-SEINÄ-VÄGG A	Scale	1:35
Material	28x135	Date	14.01.2013
Drawer	RP	File	F2941-28 Amanda.dwg

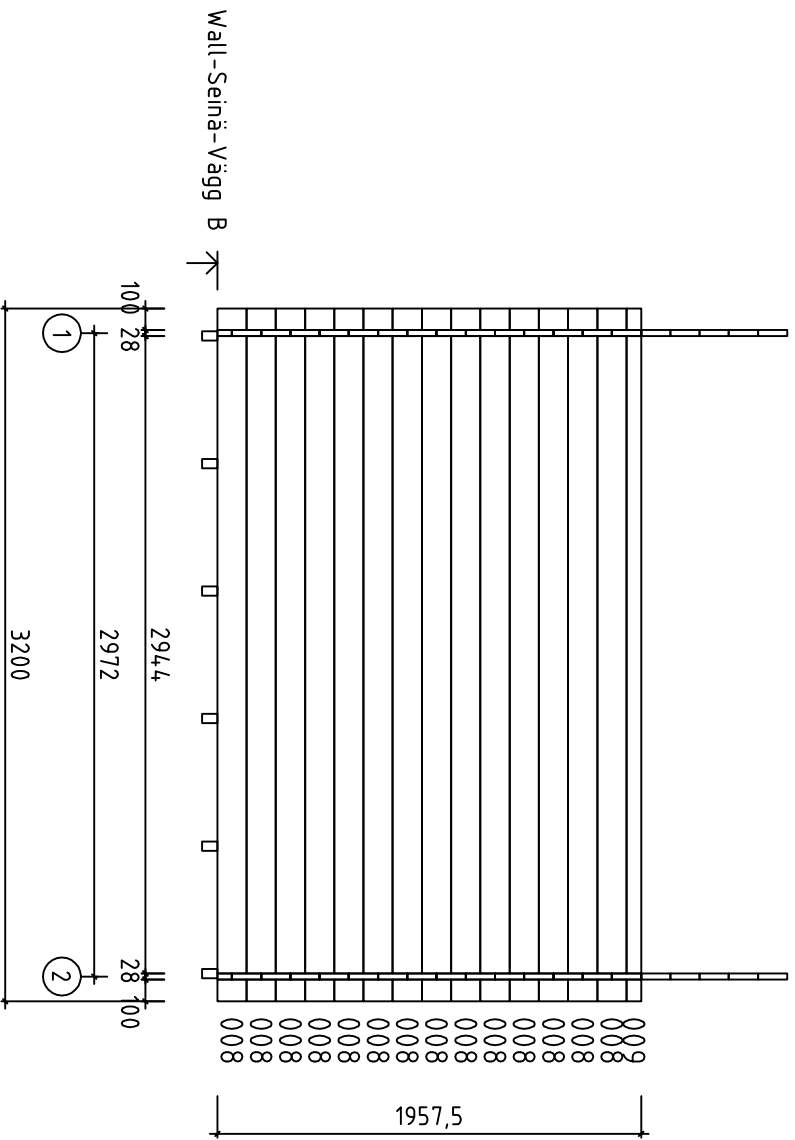

House	F2941-28 Amanda	Sheet	5
Drawing	WALL-SEINÄ-VÄGG B	Scale	1:35
Material	28x135	Date	14.01.2013
Drawer	RP	File	F2941-28 Amanda.dwg

Wall-Seinä-Vägg C ↗

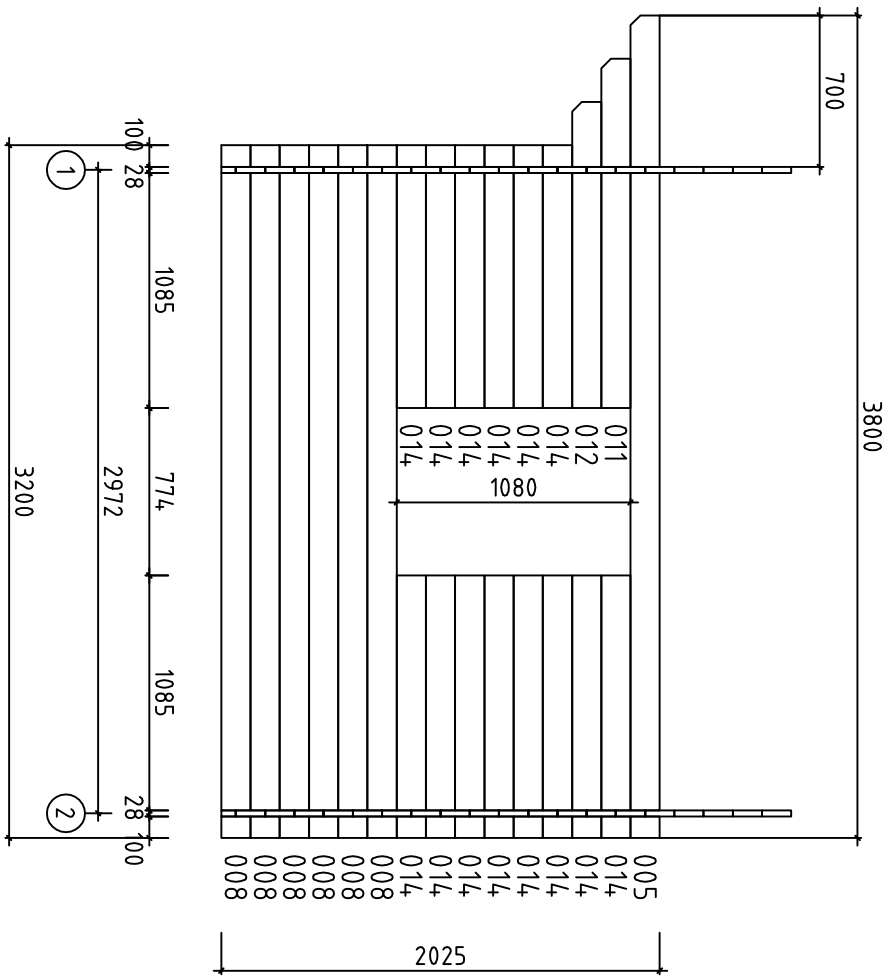

House	F2941-28 Amanda	Sheet	6
Drawing	WALL-SEINÄ-VÄGG C	Scale	1:35
Material	28X135	Date	14.01.2013
Drawer	RP	File	F2941-28 Amanda.dwg

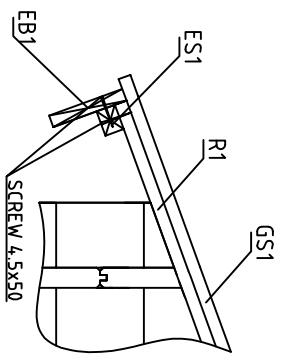



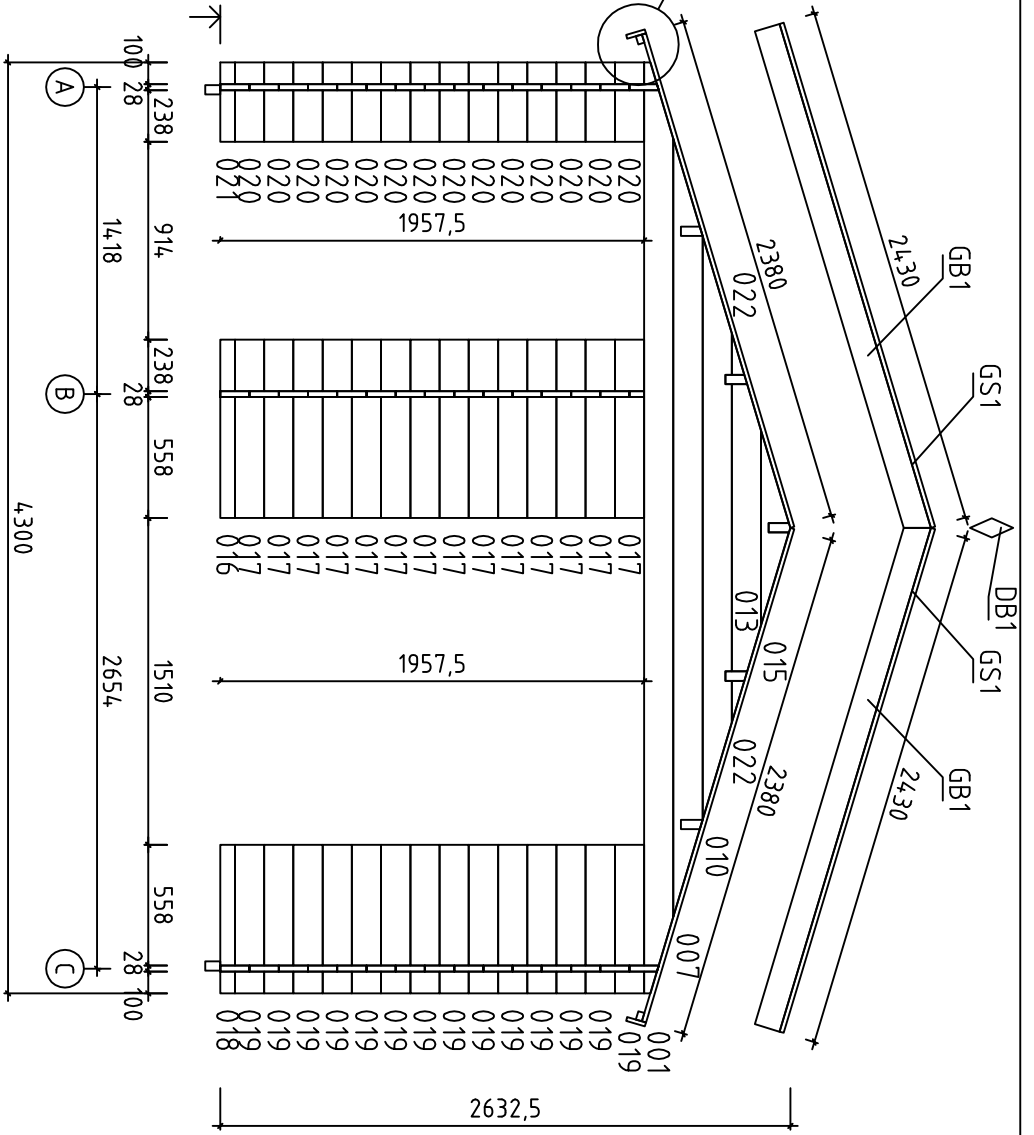

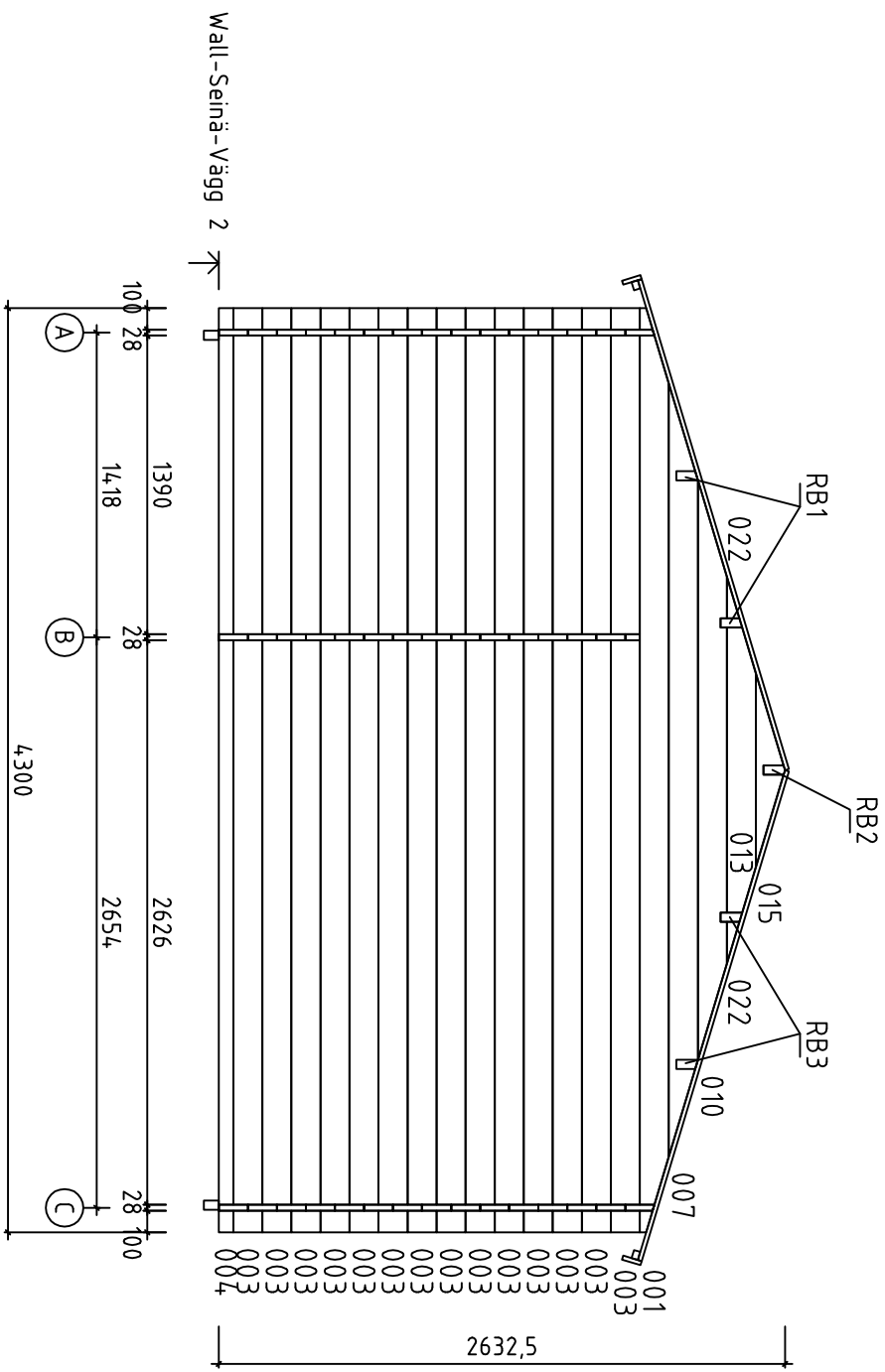

Wall-Seinä-Vägg 1



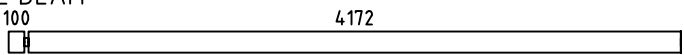
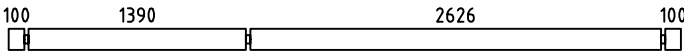
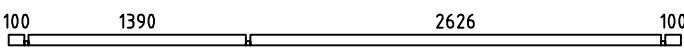
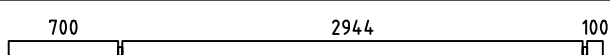
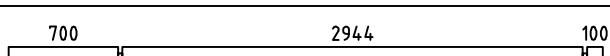
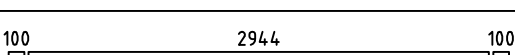
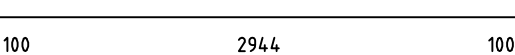
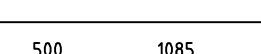
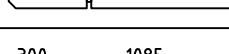
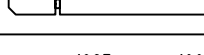
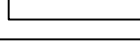
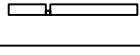
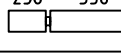
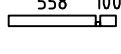

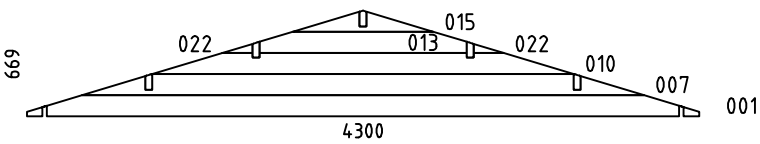

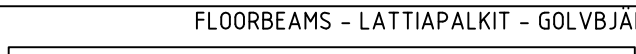
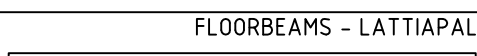
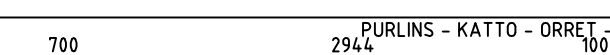
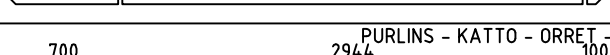
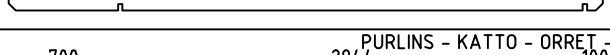





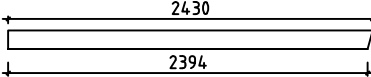









House	F2941-28 Amanda	Sheet	7
Drawing	WALL-SEINÄ-VÄGG 1	Scale	1:35
Material	28x135	Date	14.01.2013
Drawer	RP	File	F2941-28 Amanda.dwg



House	F2941-28 Amanda	Sheet	8
Drawing	WALL-SEINÄ-VÄGG 2	Scale	1:35
Material	28x135	Date	14.01.2013
Drawer	RP	File	F2941-28 Amanda.dwg

Pos	F2941-28 Amanda	Pcs. St.	Profil(e) (mm)	L (mm)
002	SPARE BEAM 	1	28x135	4300
003		14	28x135	4300
004		1	28x68	4300
005		1	28x135	3800
006		1	28x135	3800
008		26	28x135	3200
009		1	28x68	3200
011		2	28x135	1613
012		2	28x135	1413
014		28	28x135	1213
016		1	28x68	824
017		14	28x135	824
018		1	28x68	686
019		14	28x135	686
020		14	28x135	366
021		1	28x68	366
W1-1 W2-1		2	28x669	4300
HB	HIT BLOCK-ASENNUSPALKKI-MONTERINGSBJÄLKAR 	2	28x135	300
FBI2	FLOORBEAMS - LATTIAPALKIT - GOLVBJÄLKAR 	IMM	43x70	4004
FBI1	FLOORBEAMS - LATTIAPALKIT - GOLVBJÄLKAR 	IMM	43x70	2988
RB1	PURLINS - KATTO - ORRET - TAKASAR 	2	43x140	3800
RB3	PURLINS - KATTO - ORRET - TAKASAR 	2	43x140	3800
RB2	PURLINS - KATTO - ORRET - TAKASAR 	1	43x140	3800
F1	FLOORBOARD - LATTIALAUTA - GOLVBRÄDE  or	36+1 47+1	114x19 88x19	2938
House F2941-28 Amanda		Material	File F2941-28 Amanda.dwg	Sheet 9

Pos	F2941-28 Amanda		Pcs. St.	Profil(e) (mm)	L (mm)
R1	ROOFBOARD - KATTOLAUTA - TAKBRÄDE	 or	68+2 88+2	114x19 88x19	2380
FF1	SKIRTING SLAT - LATTIALISTA - GOLVLIST			19x35	20 m
GB1	GABLE BOARD - KAAPELILAUTA - VINDBRÄDE		4	19x120	2430
GS1	BOARD MATCHING WITH GABLE BOARD-KAAPELILAUTA VASTAVA LAUTA-BRÄDE OVANPA VINDBRÄDE		4	19x70	2430
EB1	EAVE BOARD - RÄYSTÄSLAUTA - TAKFOTBRÄDE		2	19x90	3800
ES1	EAVE SLAT - RÄYSTÄSLISTA - TAKFOTLIST		2	30x40	3800
DB1	DECORATIVE - KORISTE - PRYDNADS		2	19x90	200
SS1	STORM SLAT-MYRSKY LISTA-OVÄDER SPJÄLA		4	19x35	1930
	SCREWS-RUUVIT-SKRUVAR FOR-VARTEN-FÖR	SS1 	12	ø6	40
	WASHER-ALUSLAATTA-BRICKA FOR-VARTEN-FÖR	SS1 	12	ø6	
	NAILS-NAULAT-SPIKAR FOR-VARTEN-FÖR	FF1 	50	ø2.0	40
	NAILS-NAULAT-SPIKAR FOR-VARTEN-FÖR	F1, R1 	650	ø2.5	60
	SCREWS-RUUVIT-SKRUVAR FOR-VARTEN-FÖR	GB1, GS1, EB1, ES1, DB1 	60	ø4.5	50
	SCREWS-RUUVIT-SKRUVAR FOR-VARTEN-FÖR	004, 009, 016, 018, 021 FBI1, FBI2 	40	ø4.5	90
	SCREWS-RUUVIT-SKRUVAR FOR-VARTEN-FÖR	RB1, RB2, RB3 	10	ø6.0	160
	WINDOW HANDLE-IKKUNA KAHVA-FÖNSTER HANDTAG		2		
	DOOR HANDLE-OVEN KAHVA-DÖRR HANDTAG		2		
	DOOR LOCK+KEYS-OVENLUKKO+AVAIN-DÖRRLAS+NYCKLAR		2		
	DOUBLEDORR FRAME SET-PARIOVIA KARMIT-DUBBELDÖRREN RAMAR		1		
	DOUBLEDORR HINGES-TUPLAOVEN SARANAT-DUBBELDÖRR GANGJÄRN		6		
	WINDOW CROSSES-IKKUNALISTAT-FÖNSTERLIST		2		
	DOOR CROSSES-OVENLISTAT-DÖRRLIST		2		
House	F2941-28 Amanda	Material	File	F2941-28 Amanda.dwg	Sheet 10

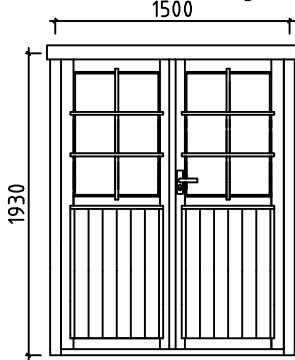
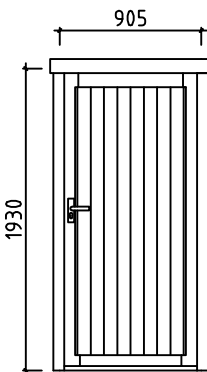
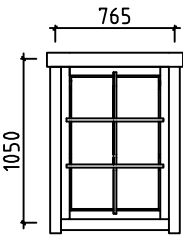
Pos	F2941-28 Amanda	Pcs. St.	Profil(e) (mm)	L (mm)
	DOOR-OVI-DÖRR (right-oikea-höger) AST_PL 	P	1	1500
	DOOR-OVI-DÖRR (right-oikea-höger) AST_PL 	P	1	905
	WINDOW-IKKUNAN-FÖNSTER (right-oikea-höger) AST_KP 	P	2	765
House F2941-28 Amanda	Material	File F2941-28 Amanda.dwg	Sheet 11	

#001	1,2	4300	2
#002		4300	1
#003	2	4300	14
#004	2	4300	1
#005	C	3800	1
#006	A	3800	1
#007	1,2	3595	2
#008	A,B,C	3200	26
#009	B	3200	1
#010	1,2	2696	2
#011	A,C	1613	2
#012	A,C	1413	2
#013	1,2	1327	2
#014	A,C	1213	28
#015	1,2	899	2
#016	1	824	1
#017	1	824	14
#018	1	686	1
#019	1	686	14
#020	1	366	14
#021	1	366	1
#022	1,2	192	4